

# Temporal Patterns of Trunk Muscle Activity throughout a Dynamic, Asymmetric Lifting Motion

CAROLYN M. SOMMERICH<sup>1</sup> and WILLIAM S. MARRAS, *Ohio State University, Columbus, Ohio*

This study examined the effects of trunk speed and exertion level on temporal aspects of trunk muscle activity patterns during dynamic, asymmetric lifting. Electromyographic (EMG) data from eight trunk muscles were collected along with trunk torque output, position, and velocity data during several repetitions of four speed/loading combination conditions. During analysis, each muscle's EMG record was reduced to three key events: a start, a peak, and an end point. For each subject, temporally ordered event lists were constructed for each test condition. Networks of events that consistently occurred regardless of loading or speed levels were constructed for each subject. Two event pairs occurred consistently for all subjects under all conditions, whereas some pairs occurred in association with specific speed or resistance levels. Temporal information related to muscle activity could be used in biomechanical models in order to predict changes in spinal loading during the course of workplace tasks.

---

## INTRODUCTION

Low back pain (LBP) and low back disorders are pervasive problems that exact high tolls on workers, employers, and societies. Lost pay, reduced productivity, spiraling medical costs, and lowered morale and quality of life are part of the price of back pain and injury. LBP is the chronic condition that most frequently limits activity of people under 45 years of age (Kelsey and Hochberg, 1988). In the United States back illness accounts for one quarter of workers' compensa-

tion claims (Jensen, 1988) and one half of the claims attributed to musculoskeletal disorders (National Institute of Occupational Safety and Health [NIOSH], 1986). Webster and Snook (1990) estimated the cost of compensable LBP in the United States to be a staggering \$11.1 billion in 1988.

Heavy lifting, frequent lifting, bending and twisting, holding unnatural static postures, prolonged sitting without proper support, and exposure to vibration have been identified as occupational risk factors associated with LBP (Andersson, 1981). Jensen (1987) compiled a list of the 10 worst occupations, in terms of highest incidence rates of back strains and sprains, based on workers' compensation claims records. Included on the list

<sup>1</sup> Requests for reprints should be sent to Carolyn M. Sommerich, Department of Industrial and Systems Engineering, Ohio State University, 210 Baker Systems, 1971 Neil Ave., Columbus, OH 43210.

were general and construction laborers, garbage collectors, warehouse employees, licensed professional nurses, nursing aides, and orderlies. Workers in each of those groups are exposed to one or more of the aforementioned occupational risk factors. Personal factors have also been linked to LBP. Anthropometry, genetics, muscle strength, and physical fitness also play important parts in the equation.

Although ergonomic intervention can begin once risk factors have been identified, the picture is not complete without an understanding of the causes of injury. Paramount to fully defining the causal relationship between an injury and an activity is an understanding of the biomechanics of that activity. Knowledge of how components of the back react under various loading conditions leads to a more complete understanding of the mechanics of injury. Spinal loading stems from a combination of external and internal sources, including the weight of body segments, inertia of moving segments, and any hand-held load, such as a box, that is lifted. External loads originate outside the body, whereas internal loads are attributable to forces from muscles, ligaments, and fascia that counteract externally imposed loads. Because forces from the muscles act at a mechanical disadvantage relative to the external forces, those internal forces are actually the primary contributors to spinal loading.

Lacking assessment techniques for directly measuring muscular forces, electromyography (EMG) has become a tool of choice for researchers wishing to study muscle activity. In general, biomechanical studies of the back have concentrated on the amplitude of EMG activity elicited by certain trunk muscles as an indication of how hard the muscles were working during specific loading tasks. These tasks have usually been performed under static or isokinetic conditions. Investigations into static trunk loading by Andersson, Or-

tengren, and Schultz (1980) and Schultz and Andersson (1981) were important in establishing relationships among trunk muscle activity levels, external loads applied to the trunk, and internal spinal loading. The muscles these researchers chose to include in their models set a precedent for future research. Many of today's spine models and lifting guidelines are based on results from these early works.

Several studies have demonstrated the importance of recognizing the differences that exist when motion is involved in a lifting task, as it usually is. In a study of the effects of constant velocity on trunk exertion capabilities, Marras, King, and Joynt (1984) found decreased torque production as trunk extension velocity increased during sagittal trunk extensions. Differences between static and dynamic exertion levels, as measured by EMG, were evident for the posterior trunk muscles. Under unrestrained sagittally symmetric lifting conditions, Kim and Marras (1987) found that the EMG activity of the trunk muscles was dependent on trunk velocity. Marras and Mirka (in press) found significant effects from velocity, torque output level, and combinations of velocity and trunk orientation (twisting and flexion) in EMG data from the trunk musculature. All of these results substantiate the existence of differences between static and dynamic loading situations and point to the necessity for further investigation of manual materials handling under conditions that more closely approximate actual workplace conditions.

Few studies of the trunk musculature have focused on the temporal patterns of muscle behavior. Studying activity patterns involves investigating the timing of portions or points of an EMG signal and may or may not involve analysis of the amplitude of the signal. This technique has been used in the past to study gait (Shiavi, 1985), the shoulder complex during baseball pitching (Jobe, Tibone, Perry,

and Moynes, 1983), and trunk biomechanics (Marras and Reilly, 1988). Marras and Reilly (1988) studied EMG activity patterns during sagittally symmetric, maximum trunk extension exertions performed at several different speeds. Their intent was to obtain information that would be useful in building a dynamic model of the trunk as well as furthering assessment of dynamic loading of the spine in the workplace. They found that an elevated degree of activity in all of the trunk muscles often occurred during an exertion. This is important because many modelers are forced, because of the static indeterminacy of the group of equations they devise, to arbitrarily assume a state of nonantagonism in order to solve their equations. Empirical results have shown that this is not an accurate assumption and may lead to underestimation of spinal loading. Temporal analysis can be used to trace spinal loading (compression and shear) throughout an exertion and to identify how loading changes, including when it reaches extremes. Marras and Reilly (1988) were able to identify points in time when exertions may become particularly hazardous because of the number of simultaneously active muscles, especially if they are at peak activity levels concurrently. Temporal analysis should enhance estimates of loading from any current EMG-driven model.

No studies published to date have examined temporal activity patterns of trunk musculature under free dynamic, asymmetric conditions—those under which people normally move. Previous studies of EMG patterns of back musculature have been performed under isokinetic conditions in a single plane. The current investigation was designed to be an initial study of the use of EMG temporal pattern analysis techniques on data collected under asymmetric postural and nonconstant velocity conditions. The specific objectives of this research were to identify temporal patterns of EMG activity for an in-

dividual under a variety of speed and loading conditions for a single motion commonly performed in the workplace; to determine whether any of those patterns could be linked exclusively to changes in either trunk speed or trunk load level; and to ascertain whether any specific patterns or changes commonly occurred among individuals.

## METHODS

### *Task*

Subjects performed a prescribed motion intended to approximate an asymmetric workplace lifting task similar to loading items from a pallet onto an assembly line. The motion began with the trunk rotated to the right and flexed, and ended with the trunk in an upright posture and rotated to the left. Two external loading (resistance) levels were supplied by the test apparatus and were intended to simulate a light or a heavier load being lifted. The two resistance levels were combined with two levels of trunk movement speed. Subjects controlled movement speeds, one of which was to be a comfortable pace and the other a faster pace, as if the line had been sped up. Subjects performed six separate repetitions of each of the four loading/speed conditions.

### *Subjects*

Five healthy male students with no history of back pain volunteered to participate in this study. Subjects ranged in age from 21 to 31 years. Subject anthropometric data are displayed in Table 1. Prior to testing, each subject signed a consent form approved by Ohio State University's Human Subjects Review Committee.

### *Independent Variables*

In previous studies of trunk musculature, both trunk velocity and external loading level were found to significantly affect trunk mus-

TABLE 1

## Subject Anthropometry

Subject	Age (years)	Mass (kg)	Height (cm)	UBHT <sup>a</sup> (cm)	L5 Depth (cm)	L5 Breadth (cm)
1	31	75.0	180.0	70.5	21.5	32.5
2	31	67.3	172.6	68.5	20.0	29.5
3	29	67.7	170.0	65.0	22.0	28.0
4	25	84.1	196.0	83.0	24.0	32.0
5	24	84.1	190.0	79.5	22.5	32.0

<sup>a</sup> This height refers to the distance between the top of the head and the fifth lumbar vertebra (L5).

cle activity. Therefore, in this study two trunk speeds and two loading levels were established as independent variables and crossed, for a total of four test conditions. The two loading categories were labeled *low* and *high*. The low level was set at the least resistance that could be selected on the test apparatus (1.4 Nm of torque). The high level was individually established during pilot testing as 35% of each subject's maximum voluntary static torque, determined separately for each axis. For the five subjects, the high extension resistance torques ranged from 40.7 to 85.5 Nm (mean = 71.2, *SD* = 18.7), and the high rotation torques ranged from 15 to 30 Nm (mean = 24.9, *SD* = 6.2).

The test apparatus constantly monitored trunk motion around all three axes, but it was not designed to control trunk speed. Consequently, through task practice, subjects were requested to establish two different trunk movement speeds—moderate and fast—and to perform them consistently throughout the experiment. The average peak rotation speeds for the moderate and fast conditions were 29.5 deg/s (*SD* = 6.9) and 48.6 deg/s (*SD* = 12.0), respectively. The corresponding speeds in extension were 20.9 deg/s (*SD* = 4.1) and 33.3 deg/s (*SD* = 8.6), respectively. Subjects were able to achieve similar speeds under both loading conditions. The low-speed/low-load condition was treated as the control test condition.

*Dependent Variables*

EMG data were collected from the following left (L) and right (R) pairs of trunk muscles: latissimus dorsi (LDL and LDR), erector spinae (ESL and ESR), rectus abdominis (RAL and RAR), and external oblique (EOL and EOR). Because of the asymmetric nature of the task, data from muscle pairs were analyzed separately. Data were also collected from the test apparatus; this consisted of position, velocity, and subject torque output around each of the three axes, with L5 as the point of rotation.

*Apparatus*

*Multiaxial dynamometer.* Testing was performed on a B200 isodynamic testing station on loan at the time from Isotechnologies, Inc. (see Figure 1). For each subject, the appropriate resistance torques (external loading) were set independently for each of the three axes. The center of rotation of the device corresponded to the subject's L5 vertebra. Motion was restricted below that level and fully monitored above it. Trunk rotational velocity around each of the axes, though controlled by the subject according to the experimenter's instruction, was continuously measured by the B200.

*Path control device.* This device was designed to ensure that each subject would move along a similar path of motion. Al-



Figure 1. Apparatus and subject positioned for testing.

though the task was considered to be free dynamic in that velocity and acceleration were controlled only by the subject, unless each subject's movement was restricted to the same path, there would be no opportunity to check for repeated activity patterns either across trials for any one subject or between subjects. Industrial tasks and workstations often impose such restrictions on employee movement.

Each subject wore a breastplate over the shoulders and upper torso with a pointer extending out from the front. Subjects were told to keep the pointer tip within a groove cut into a board positioned in front of the subject. The width of the groove provided approximately  $\pm 3$  deg of trunk motion tolerance along the path of movement. Metal strips outlined the groove, and if contact between probe and strips occurred, a buzzer would

sound. If this occurred (although it seldom did), the trial would be repeated until it was performed with sufficient control. After a short practice session, most subjects were able to perform the task with the required amount of control under all conditions.

*EMG equipment.* Surface electrodes were used to monitor electrical activity in the eight muscles of interest. Signals from the electrodes were carried to preamplifiers located approximately 15 cm away. The preamplifiers amplified the EMG signal 1000 $\times$ . The signal was then transmitted via shielded cables to the main EMG system, where it was amplified a second time and rectified. The gain on this system was set at 55.55 $\times$ . The low-pass filter was set at 1000 Hz and the notch filter at 60 Hz. From this point the signals were transmitted, along with the B200 data, to the data acquisition system and then to a personal computer for storage and subsequent analysis.

#### *Procedure*

*Subject preparation.* A brief warm-up and stretch-out period was allotted, followed by the collection of anthropometric data. Instructions were given to each subject regarding the type of motion being simulated and the necessity for developing and maintaining two consistent and different speeds for the experiment.

Surface electrodes were attached over the eight trunk muscles. Placement positions were located via palpation and the use of bony landmarks. The skin surface was prepared by swabbing with alcohol followed by abrasion. Electrolytic gel was applied and surface electrodes set in place. The resistance between each pair of electrodes mounted over the same muscle was checked and compared with that of the other pairs. Any resistance found to significantly differ was corrected by reattachment of one or both of the electrodes involved.

The next step was to secure the breastplate over the subject's torso. The subject was then positioned and secured in the B200. All necessary adjustments were made to ensure proper alignment and positioning of the subject. The control board was then moved into place and aligned. The subject was given time to familiarize himself with the restrictions of the equipment and the task to be performed. After the subject acknowledged that he was comfortable with the arrangement, actual testing began.

*Static maximums.* Each subject performed a series of static maximum exertions in the three planes of motion in order to establish a test level for the high-force condition. Subjects were tested under static conditions, with each exertion lasting 3 s, with 2-min rest breaks in between. The high-force resistance around each of the three axes was set at 35% of the subject's maximum for the individual axes.

*Testing.* Each subject performed six repetitions of each of the four test conditions, for a total of 24 trials. Subjects were given 2 min to rest between exertions. For the high-force trials, subjects were assisted to the starting position to lessen the chance of fatigue.

#### Method of Analysis

*Characteristic events.* For each trial four characteristic events were identified within each muscle's EMG record. Each EMG trace was examined and a starting point was identified subjectively as the point at which an elevated amplitude was noticeable. An ending point was identified as the point at which EMG activity returned to its original level. A peak point, identified by a computer program, was located between these two points. In some instances it became necessary to identify a secondary starting point because some elevated activity was evident but was not the start of the main activity portion of the trace. The corresponding times for each of

these events would be the basis for the analysis. These were defined as follows (refer to Figure 2): Event 1 was the starting point of muscle activity, Event 2 was the starting point of the primary elevated activity region, Event 3 marked the peak of the activity, and Event 4 marked the return to resting level. Events 1 and 2 were often identical. In several instances no starting point and no real elevation in the trace could be detected. In these cases the muscles were considered to be inactive.

*Ordering events.* After we determined the four points in time corresponding to the four characteristic events, each event was placed in order of occurrence. A listing of events was created for each trial. After the creation of event orders for each repetition, event lists for a given subject and condition were combined. This process yielded information on the occurrence of each of the 32 events relative to one another. Provided that a muscle was active during a trial, there were three possible ways to describe the order relationship between that muscle's characteristic events and those of each of the other muscles. Either one preceded the other, followed the other, or occurred simultaneously. These relationships are referred to as *event pairs* in the remainder of the text. This analysis technique

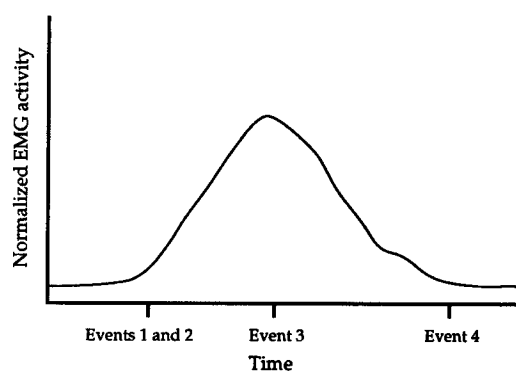

Figure 2. Example of characteristic events for EMG activity in one muscle.

was similar to that employed by Marras and Reilly (1988).

*Final analysis.* Once established for each subject, the event relationships were then used to develop a baseline order of events that always occurred, regardless of test condition. Event networks—the conglomeration of all event relationships between muscles for a given condition and subject—were constructed from those consistently occurring relationships. Comparisons were made between test conditions in order to determine which relationships were associated with specific velocity or resistance levels. After individual results were tabulated, they were compared with results from the other subjects to determine whether any event relationships held true across subjects or were strictly subject-specific phenomena.

## RESULTS

### *Universal Results*

*Independent of condition.* Two consistent relationships (event pairs) were identified for all conditions. First, ESL always began its period of elevated activity (Events 1 and 2) earlier than did EOR (Event 2). Second, ESL peak activity consistently occurred prior to the EOR peak.

*Condition-dependent.* One event pair occurred in this category. Consistently and exclusively under high-torque conditions, regardless of velocity, the EOL began both initial and primary activity prior to the occurrence of peak activity in the ESL. Additionally, for each subject, increasing either velocity or torque resulted in recruitment of additional muscles—though not always the same additional muscles—beyond those recruited in the control condition.

### *Common Results, Two or More Subjects*

*Independent of condition.* Consistently occurring event pairs were noted across all test-

ing conditions for the four subjects who consistently displayed activity in ESR; these are depicted in Figure 3. In that figure, for example, all event pairs designated by number 1 occurred under all test conditions for those subjects who consistently recruited ESR under all test conditions. Also recorded in that figure are the event pairs seen to occur for subjects who consistently displayed activity in one or more of the following muscles: RAL, RAR, or EOL. Those event pairs are designated by a 2, 3, or 4, respectively, in the figure. Each of those muscles was consistently active for three of the five subjects.

*Condition dependent.* Subjects displayed many resistance-related event order pairs. Figure 4 depicts those event pairs common to two or more subjects. In that figure event pairs are marked by group designation numbers that identify subjects who commonly displayed a particular event pair. Those marked with a single asterisk reversed order between resistance conditions. The number of resistance-related event pairs greatly exceeded the number of velocity-associated event pairs. A few of the existing velocity-related occurrences were common to two or more subjects and are displayed in Table 2.

### *Individual Subject Results*

*Independent of condition.* Event order results that held for particular subjects throughout all speed and loading combinations were summarized in muscle recruitment/usage networks. These baseline networks are depicted in Figures 5a–5e. In the figures, consistently occurring event pairs are connected by arrows. No consistent temporal relationships could be established between events that are not connected. Similarities and differences in consistent muscle recruitment across all conditions can be seen in these figures as well.

*Condition dependent.* Events that occurred only in either high-force or low-force condi-

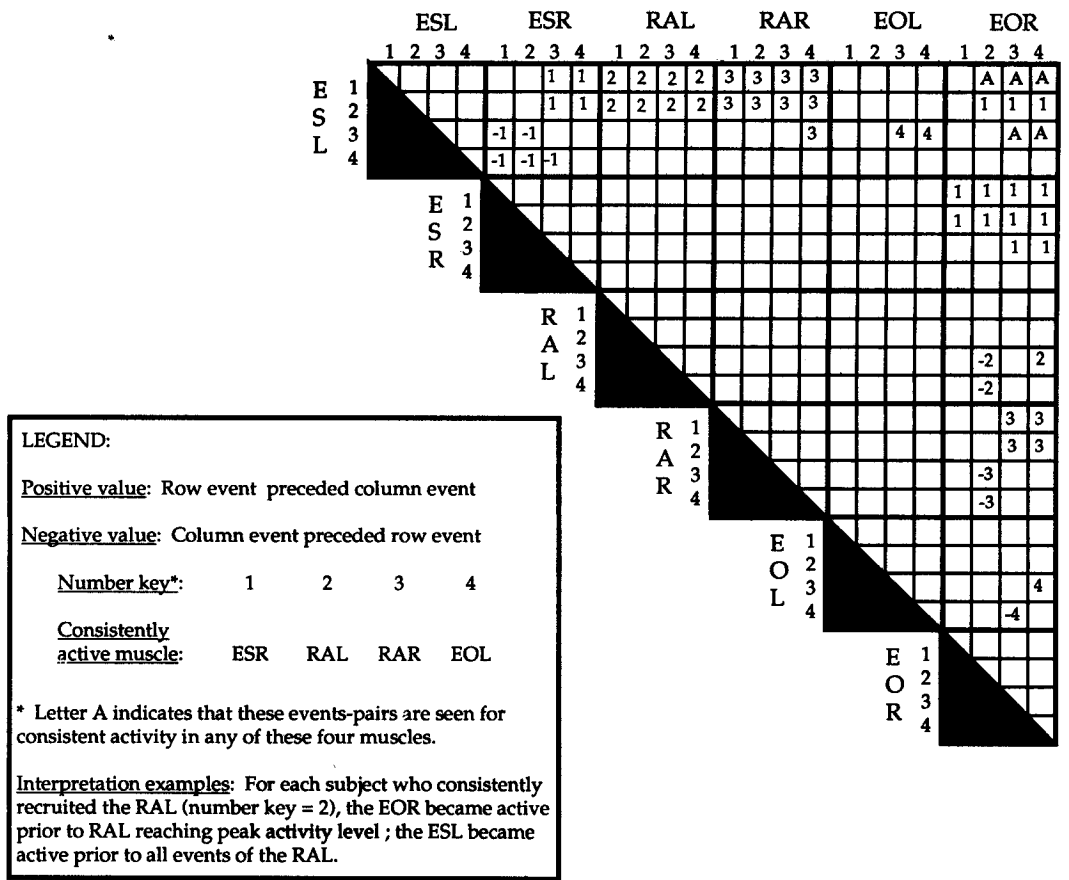

Figure 3. Event pairs that occurred across all conditions, for those subjects who displayed activity in either the ESR, RAL, RAR, or EOR.

tions, regardless of velocity, were identified for each subject. Each subject also displayed velocity-correlated events related to either the fast or slow trunk motion speed conditions. As an example, the condition-dependent findings for one subject are presented in Figure 6. Only one subject displayed a majority of velocity-related event pairs, whereas four of the five presented more resistance-associated relationships.

**DISCUSSION**

This analysis technique, which was designed to detect temporal patterns of trunk

muscle recruitment and activity throughout a dynamic exertion, proved to be successful in the examination of the asymmetric lifting motion performed in this study. Both intersubject differences and similarities in activity patterns were identified. Consistent effects of velocity and resistance levels could be seen for the individuals and for the group.

*Muscle Activity Patterns*

*Posterior muscles.* The analysis began with construction of baseline activity networks for each subject. From these, intersubject similarities were identified. As was mentioned in



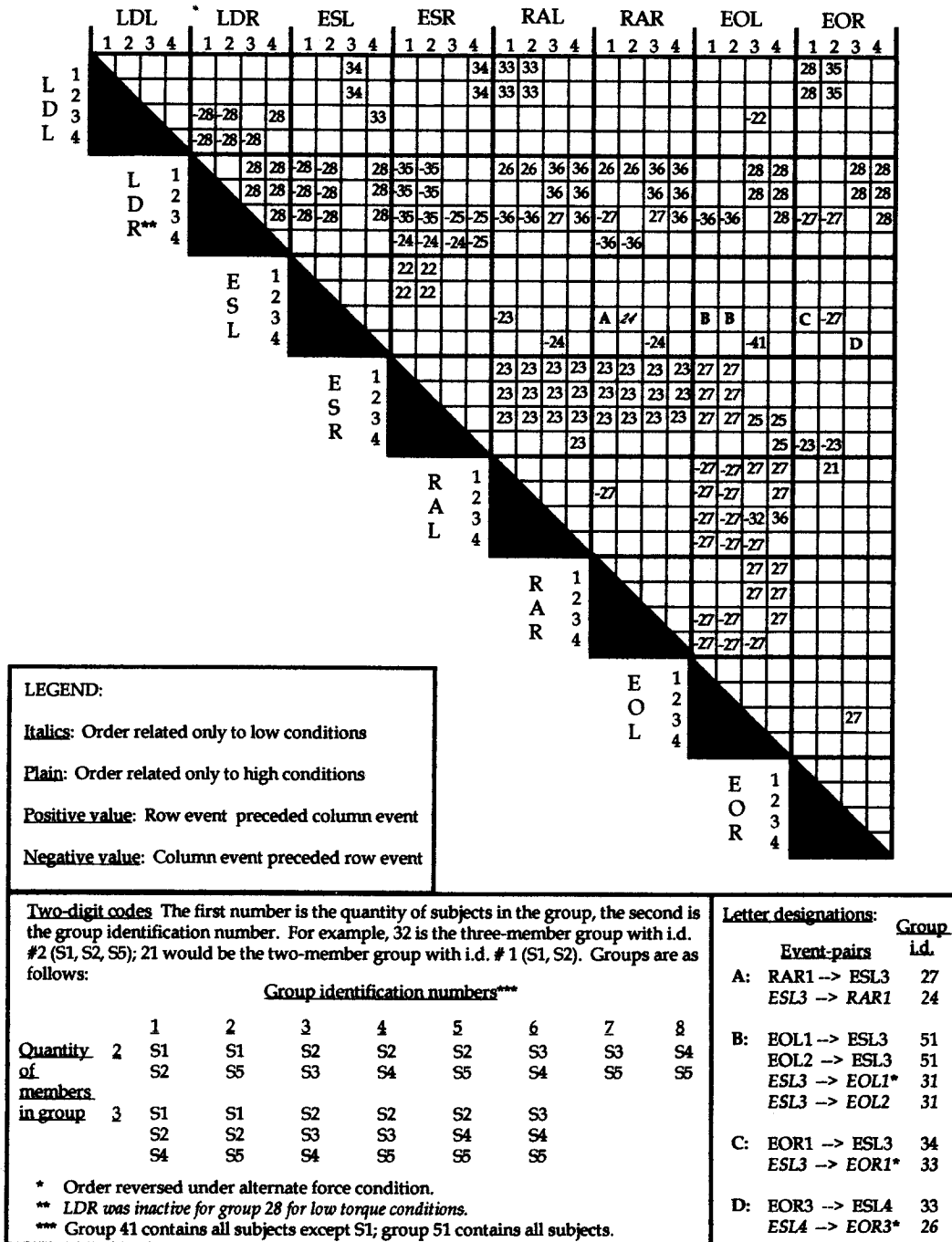

Figure 4. Torque-level-dependent event pairs common to two or more subjects. Two-digit values are subject codes.

TABLE 2

Velocity-Related Events that Occurred for Two or More Subjects

<i>First Event</i>	<i>Subsequent Event</i>	<i>Subjects</i>
ESR4	LDL4	S3, S4
RAR4	LDL4	S1, S4
EOL3	ESR4	S1, S4
EOR3	ESR4	S1, S4

Note: All events occurred under fast speed conditions.

the results section, two event pairs regularly occurred for the entire group. The ESL and EOR were consistently recruited by each subject. The erector spinae are the prime extensor muscles, and the external obliques are positioned to effect rotation. The two event pairs that occurred were consistent with the task motion, an extension with the torso in a diminishing asymmetric twist to the right followed by a continued rotation to the left. Therefore it follows that initial ESL activity preceded EOR activity and that peak activity in ESL preceded that of EOR. That ESR was not consistently recruited is a reflection of the asymmetry of the task, which placed that muscle at a disadvantage in both length and position to contribute to extension. All subjects did display consistent event pairs involving the ESR under the high-force condition. However, that muscle's contribution to the extension was probably still less than that of the ESL. This was determined to be the case in two earlier studies involving trunk asymmetry (Pope, Andersson, Broman, Svensson, and Zetterberg, 1986; Schultz et al., 1982). In the current study subjects consistently employed the prime trunk movers, the agonist muscles. Individual differences in activity patterns were the result of co-contraction of additional trunk muscles.

The latissimus dorsi (LD) displayed consistent baseline event ordering for only one subject. Regular patterns of activity in these muscles did not occur for most subjects until

speed and/or torque requirements increased from the control condition. Marras and Mirka (in press) found that LD activity for an asymmetric lifting task was affected by the interactions among trunk velocity, trunk flexion angle, and torque level. When the LD were fully flexed, the effects of velocity were not as pronounced as for lesser flexion angles. There was always a consistent increase in activity in response to increased torque. For the control condition in the current study, it may have been the case that because the LD were not positioned to be very effective at the beginning of the task—in addition to the fact that the task was not particularly heavy or fast—most subjects did not recruit these muscles in that condition. The LDL was consistently utilized by all subjects for the high-torque conditions and by four of the five subjects for the high-speed conditions, probably to supplement the ESL. With the exception of one subject for the high-torque conditions, the peak activity in those two muscles occurred at approximately the same time.

*Anterior muscles.* The consistent recruitment of the EOR in this study is in agreement with previous findings. Pope et al. (1986), in their study on the effects of axial torque production on trunk muscle activity, found that the EOR generated more tension than either EOL, both rectus abdominis, or both internal obliques. They pointed out that the rectus abdominis muscles are not positioned to effect twisting when a subject is in the neutral position. They noted that trunk posture could affect this, which may partially explain why there were inconsistent patterns of usage for those muscles among subjects in the current study.

#### *Condition-Related Results Common to Two or More Subjects*

Consistently occurring event pairs related specifically to torque level or velocity are presented in Figure 4 and Table 2, respectively.

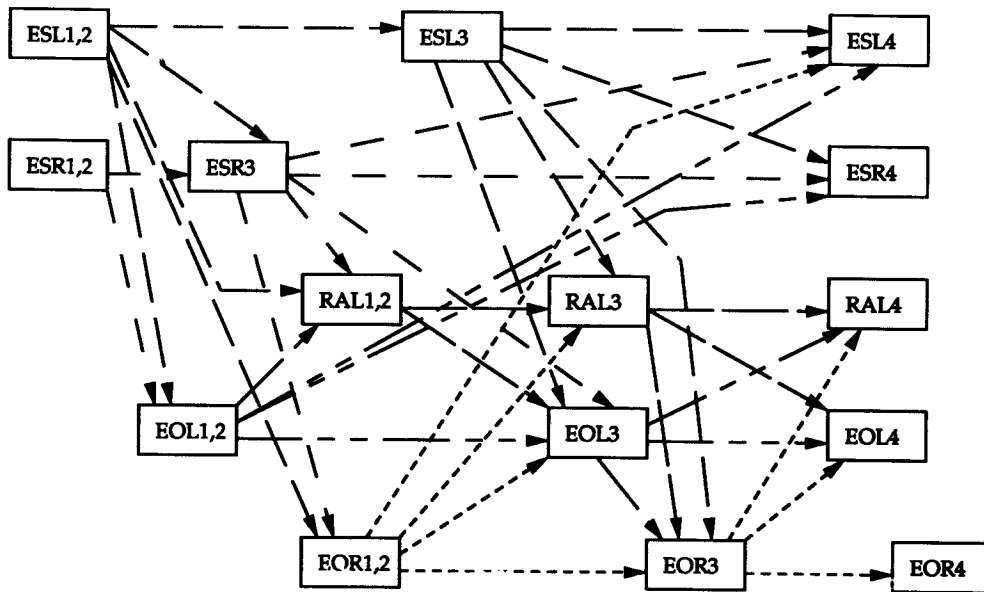

Figure 5a. Baseline networks of muscle activity patterns. For ease in tracing connections, a different line pattern was used for each muscle. Subject S1.

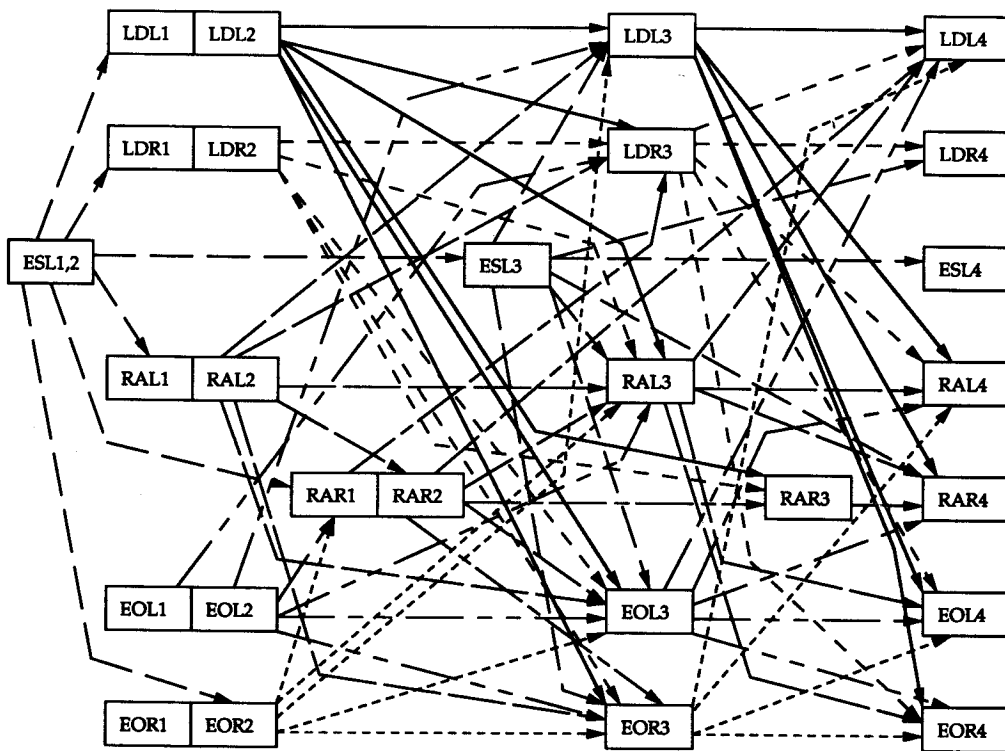

Figure 5b. Subject S2.

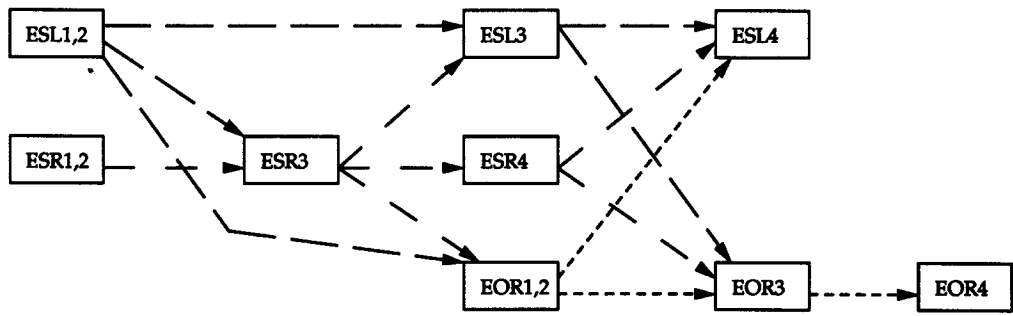

Figure 5c. Subject S3.

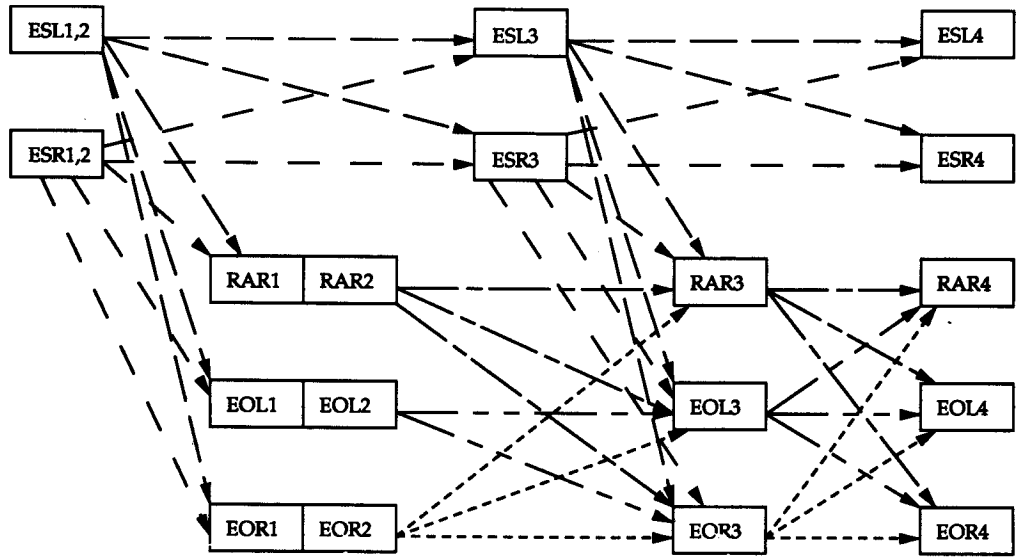

Figure 5d. Subject S4.

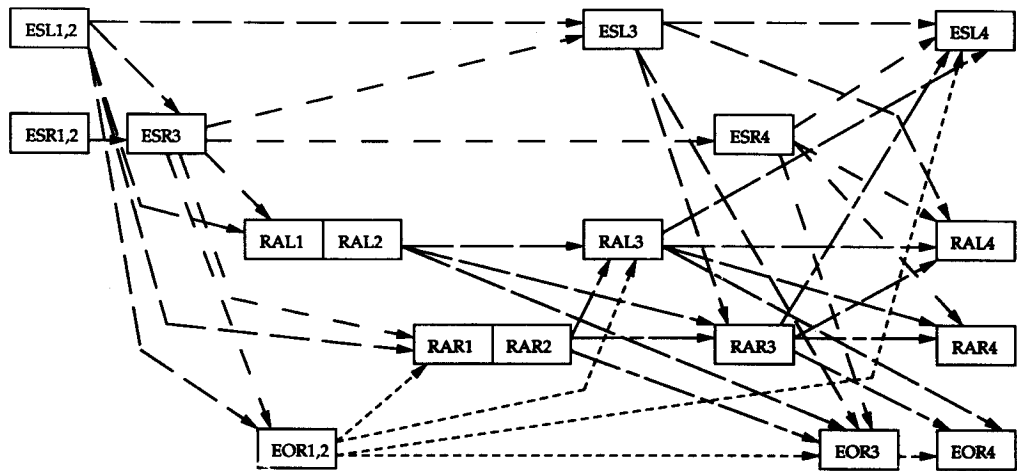

Figure 5e. Subject S5.

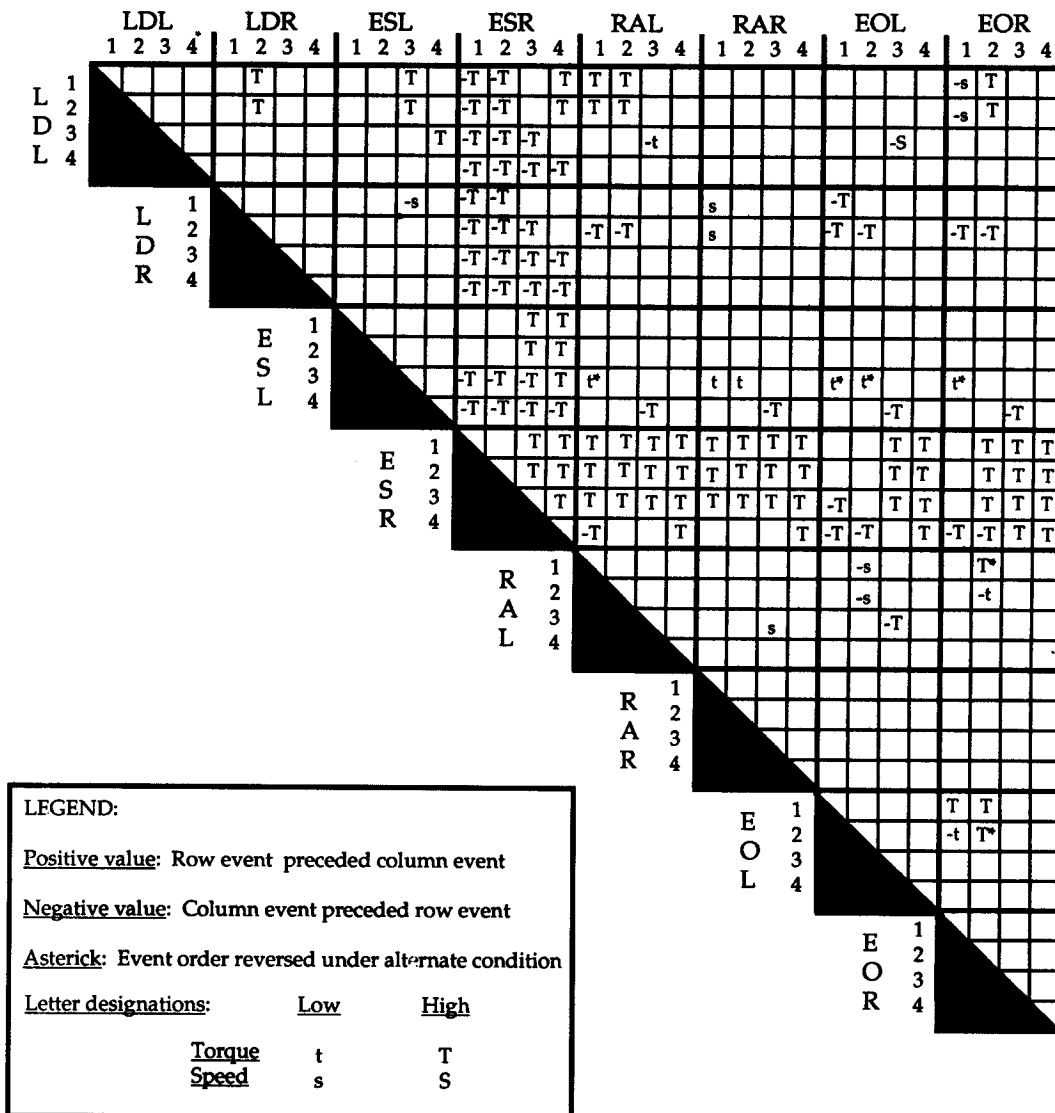

Figure 6. Torque- and velocity-level-dependent, consistently occurring event pairs for one subject (S2).

Approximately one third of the event pairs listed occurred for three or more subjects. The remainder were common to only two subjects. These findings have important implications for biomechanical modeling. They indicate that although there are commonalities in the muscular activity patterns among people performing the same task, there are

also numerous differences. If these differences are not accounted for (if models are not tested for their sensitivity to these differences), then misleading or, at best, very narrow results and predictions may be the consequence. Results such as ours signal the need for development of biomechanical models that are EMG-driven and can account for

these individual differences (Marras and Sommerich, 1991; McGill and Norman, 1986), something more general models were not designed to do.

In hopes of discovering links between subjects with event pairs in common, we examined a limited number of parameters, including anthropometric data, average trunk speeds, and average high-torque output. However, none of them provided an exclusive tie between subjects. Numerous characteristics that were not measured or sampled, including training background, strength capacity of individual muscles, maximum attainable trunk speed, or any of the myriad anthropometric measurements not taken in this study, might provide that link. The conclusion from this should not be that there are no commonalities to explain why some events are common between certain subjects, only that none was uncovered in this study.

It should be emphasized that the subjects were not highly skilled at the study task. Although the B200 was balanced with counterweights, moving in the apparatus was still different from moving when unencumbered. Perhaps part of the reason we observed less consistency than we might have expected, given the control exercised over the movement, was the lack of practice among subjects. If the subjects for this study had had manual materials handling experience—perhaps actually loading or unloading a conveyor belt—they might have exhibited more consistent and extensive muscle activity patterns, both as individuals and as a group. The subjects in the current study may have practiced enough to perform the task to the level of skill required, but they may not have been truly proficient. Keele (1986) discussed skill learning as a process of method selection. Subjects may not have had a sufficient amount of practice to select, from the wide variety of patterns available, a preferred method of task performance and, hence,

could not display more consistent patterns of muscle activity.

#### *Event Pair Order Reversals*

Some of the most interesting results were the event pair reversals presented in Figure 4. One third of these were common to two or more subjects. These reversals followed a general trend. Under the low-torque condition the first event pair member to occur was a higher-numbered event than the subsequent event. For example, ESL3 occurred prior to EOR1 for the less strenuous condition. However, for the higher torque conditions EOR was activated prior to the peak activity event of ESL. This may reflect a need for greater trunk stability under more demanding tasks, or perhaps the muscles with the lower-numbered events needed more time to reach the necessary activity level than was the case under the low-resistance condition. Not only were the activity levels of these muscles undoubtedly greater for the high-torque condition, but spinal loading was also increased for a longer period because activity in these muscles overlapped to a greater extent in those circumstances. Only temporal analysis of the EMG signals could detect these variations in muscular activity patterns.

#### *Uses for Subject-Specific Data*

Subject-specific muscle activity patterns could prove to be valuable screening tools for new job assignments, changes in job performance technique, or recovery assessment. A network that illustrates the workings of a person's trunk musculature while performing a task could prove to be a valuable record—a snapshot that could be contrasted with pictures taken over a period of time to reveal changes that might indicate injury or a weakening in the system. Changes in networks might be used to establish limits on the length of time workers should be assigned to

certain jobs with a high risk of injury. By sampling several workers, this method of analysis might also be used to identify worst-case patterns of activity for particular lifting tasks. The information could be used to guide modelers and job designers. In a rehabilitation situation, networks might be used as part of an overall program in determining when, if ever, the employee should return to work or to a particular job.

#### *Obstacles to the Study of Free Dynamic Motion*

One major difficulty in studying free dynamic activity is the limitation on the information that can be gleaned from EMG signals recorded under such circumstances. In particular, attempts to correlate EMG amplitude to muscle tension level should be discouraged when no control is exercised over velocity or acceleration. This study did not attempt to relate EMG amplitude to specific muscle tension levels; instead, we examined recruitment timing of several trunk muscles. Timing of muscle activity alone, though not yielding quantitative information regarding muscle activity levels or spinal loading levels, was found to yield additional vital information ignored by studies that concentrate on loading at one point in time: impulse loading. Research that addresses the order of occurrence of muscle activity events, such as those events detailed in Marras and Reilly (1988), and changes to those orders when movements are performed under differing loading conditions, can focus on questions regarding muscle use for posture or motion, timing of the occurrence of antagonistic activity, spinal loading throughout an exertion and identification of peak loading periods, and the effects of the speed of load application on muscle recruitment timing and order. Answers to these questions will help to paint a more complete picture of the loading of the spine

and the control system that regulates movement performance.

Another obstacle to the study of free dynamic motion is the variation in activity patterns between subjects. It is difficult to develop a predictive model of activity when everyone is doing something different. Bobet and Norman (1982) found a high degree of variability among their subjects in a study of EMG activity in the back and legs during performance of a backpack-carrying exercise. They suggested that the unconstrained nature of the movements led their subjects to adopt different motor patterns in order to accomplish the same task. In the current study it was shown that even a constrained movement performed at self-selected speeds leads to a high degree of variability, at least among unskilled subjects.

#### CONCLUSIONS

This study revealed that individuals display specific muscular recruitment patterns that are detectable via the method of analysis described in this paper. The discovery of so many condition-related event pairs per subject, as well as the encouraging number of event pairs in common among subjects (even if only between two), is a signal that the analytical technique can find trends in the data and that event-time networks are a viable source of biomechanical information on the back, albeit often an individual back. Muscle recruitment patterns are not extensively utilized in the study of back biomechanics. However, this and other studies that employed the technique have shown that the information from this method of EMG analysis will provide valuable supplemental input to future dynamic biomechanical models. Uses exist for both the group and individual data that this type of investigation can supply.

This investigation was an initial attempt to produce networks for an asymmetric, non-isokinetic movement. The information that

came to light regarding the ability to identify repeatable patterns and relationships between muscle event occurrences, and linking those patterns to changes in trunk speed and torque production, suggest that this technique supplies new information that cannot be obtained by traditional methods of EMG analysis. Because this is new information, current standards for lifting (NIOSH, 1981)—which were not devised with the aid of this knowledge and which tend to summarily ignore antagonistic muscle activity—may overestimate workers' lifting tolerances, thus perpetuating the problem of low back pain and injury that these very standards were intended to attack. Future work with EMG networks should concentrate on examining tasks similar to those found in the workplace. Networks that include quantitative timing information, as well as information describing the relative contributions of each of the muscles being monitored, will provide a more complete picture of spinal loading.

#### ACKNOWLEDGMENT

This work was partially funded by the National Institute of Disability and Rehabilitation Research. The authors wish to thank Isotechnologies, Inc. (North Carolina) for the loan of the B200 isodynamic dynamometer used in this study.

#### REFERENCES

- Andersson, G. B. J. (1981). Epidemiologic aspects on low-back pain in industry. *Spine*, 6, 53–60.
- Andersson, G. B. J., Ortengren, R., and Schultz, A. (1980). Analysis and measurements of loads on the lumbar spine during work at a table. *Journal of Biomechanics*, 13, 513–520.
- Bobet, J., and Norman, R. W. (1982). Use of the average electromyogram in design evaluation: Investigation of a whole-body task. *Ergonomics*, 25, 1155–1163.
- Jensen, R. C. (1987). Disabling back injuries among nursing personnel: Research needs and justification. *Research in Nursing & Health*, 10, 29–38.
- Jensen, R. C. (1988). Epidemiology of work-related back pain. *Topics in Acute Care and Trauma Rehabilitation*, 2(3), 1–15.
- Jobe, F. W., Tibone, J. E., Perry, J., and Moynes, D. (1983). An EMG analysis of the shoulder in throwing and pitching: A preliminary report. *American Journal of Sports Medicine*, 11, 3–5.
- Keele, S. W. (1986). Motor control. In K. R. Boff, L. Kaufman, and F. P. Thomas (Eds.), *Handbook of perception and human performance* (pp. 30-1–30-60). New York: Wiley.
- Kelsey, J. L., and Hochberg, M. C. (1988). Epidemiology of chronic musculoskeletal disorders. *Annual Review of Public Health*, 9, 379–401.
- Kim, J. Y., and Marras, W. S. (1987). Quantitative trunk muscle electromyography during lifting at different speeds. *International Journal of Industrial Ergonomics*, 1, 219–229.
- Marras, W. S., King, A. I., and Joynt, R. L. (1984). Measurements of loads on the lumbar spine under isometric and isokinetic conditions. *Spine*, 9, 176–187.
- Marras, W. S., and Mirka, G. A. (in press). A comprehensive evaluation of trunk response to asymmetric trunk motion. *Spine*.
- Marras, W. S., and Reilly, C. H. (1988). Networks of internal trunk-loading activities under controlled trunk-motion conditions. *Spine*, 13, 661–667.
- Marras, W. S., and Sommerich, C. M. (1991). A three-dimensional motion model of loads on the lumbar spine: Part 1. Model structure. *Human Factors*, 33, 123–137.
- McGill, S. M., and Norman, R. W. (1986). Partitioning of the L4-L5 dynamic moment into disc, ligamentous, and muscular components during lifting. *Spine*, 11, 666–677.
- National Institute for Occupational Safety and Health. (NIOSH). (1981). *A work practices guide for manual lifting*. (Tech. Report No. 81-122). Cincinnati, OH: Author.
- National Institute for Occupational Safety and Health. (NIOSH). (1986). *Proposed national strategies for the prevention of leading work-related diseases and injuries—musculoskeletal injuries* (DHHS [NIOSH] Publication 89-129). Washington, DC: U.S. Department of Health and Human Services.
- Pope, M. H., Andersson, G. B. J., Broman, H., Svensson, M., and Zetterberg, C. (1986). Electromyographic studies of the lumbar trunk musculature during the development of axial torques. *Journal of Orthopaedic Research*, 4, 288–297.
- Schultz, A. B., and Andersson, G. B. J. (1981). Analysis of loads on the lumbar spine. *Spine*, 6, 76–82.
- Schultz, A. B., Andersson, G. B. J., Haderspeck, K., Ortengren, R., Nordin, M., and Bjork, R. (1982). Analysis and measurement of lumbar trunk loads in tasks involving bends and twists. *Journal of Biomechanics*, 15, 669–675.
- Shiavi, R. (1985). Electromyographic patterns in adult locomotion: A comprehensive review. *Journal of Rehabilitation Research and Development*, 22(3), 85–98.
- Webster, B. S., and Snook, S. H. (1990). The cost of compensable low back pain. *Journal of Occupational Medicine*, 32, 13–15.